

MM Caster Camber Plates, 2015+ (Mm6CC-10)



Maximum Motorsports continues our tradition of designing and manufacturing the highest quality suspension components for the latest generation Mustang. Offering the same great functionality that our Caster Camber Plates have long been famous for, Maximum Motorsports has once again set an industry standard!

- A must for any lowered S550 Mustang, the MM Caster Camber Plates allows the factory camber settings to be achieved when lowering your vehicle.
- 1.75-degree continuous range of camber adjustment provides alignment correction on lowered cars.
- Caster adjustment provides correction for vehicle pull due to excessive road crowning.
- Caster and camber are easily adjusted at the top of the strut tower.
- PTFE lined spherical bearing eliminates deflection and precisely locates the strut shaft, while still allowing the required articulation.
- All parts are either plated or powder coated for great looks and long lasting protection.
- Reuses factory upper spring perch and rubber isolator.
- Lifetime warranty against spherical bearing and bearing plate failure.

Read all instructions before beginning work. Following instructions in the proper sequence will ensure the best and easiest installation.

Required Tools

- Standard assortment of hand tools
- Floor Jack & 2 jack stands
- 1/2" Torque Wrench
- Spring Compressor

Installation Time

- Shop: 2.0 Hours
- Home Mechanic: 3.0 Hours

Supplemental Installation Notes

- Alignment is required after installation
- The Factory Ford Service Manual states that the fasteners being removed in the following steps should not be reused. Replacement hardware can be purchased through your local Ford Dealer. Please see the table below for the required fasteners.

Description	Part #	Qty.
Strut-to-spindle bolt	W715932-S439	4
Strut-to-spindle nut	W520517-S450	4
Caliper mounting bolt	W716471-S439	4
Stabilizer link nut	W712503-S440	2
OEM strut shaft nut	W520215-S440	2

This Kit Contains

Description	Qty.
Bearing Plate Assembly, Driver	1
Bearing Plate Assembly, Passenger	1
Stud Plate	2
Support Bracket, Driver	1
Support Bracket, Passenger	1
Flange Nut, M10-1.5	6
3/8" G8 Washer	6
Installation Instructions	1

Component Identification

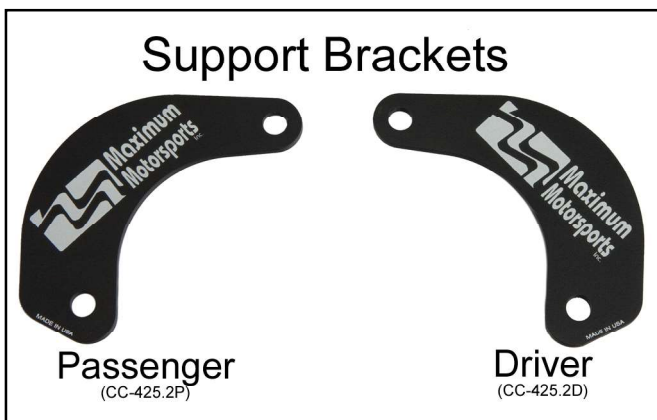
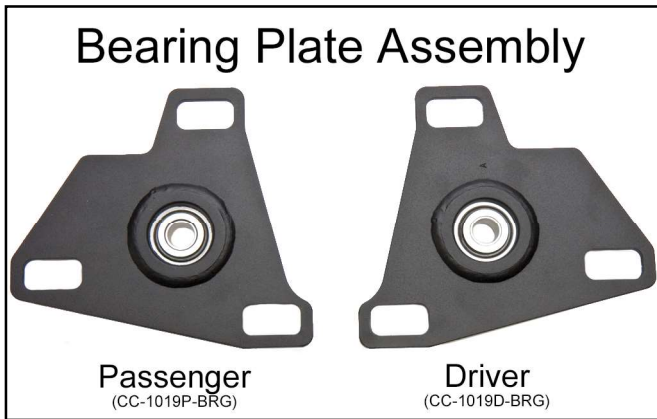

Component Preparation

1. Orient the stud plates with the bearing plate assemblies as shown below before continuing. The horizontal notch in the stud plate should be parallel with the horizontal edge of the bearing plates.

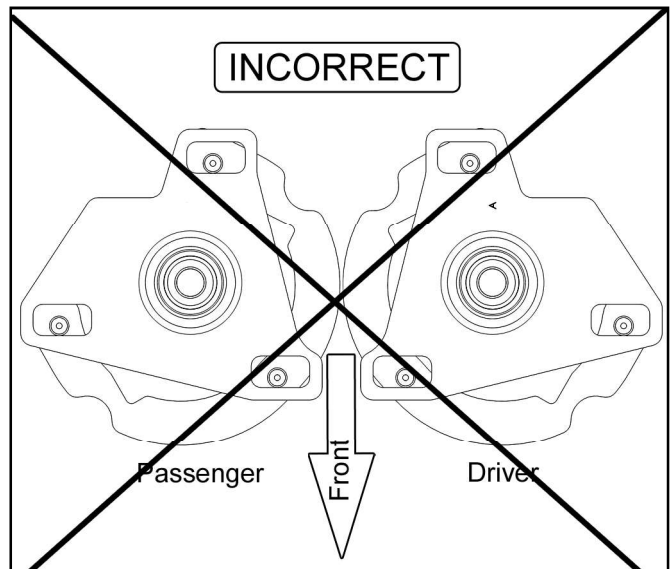
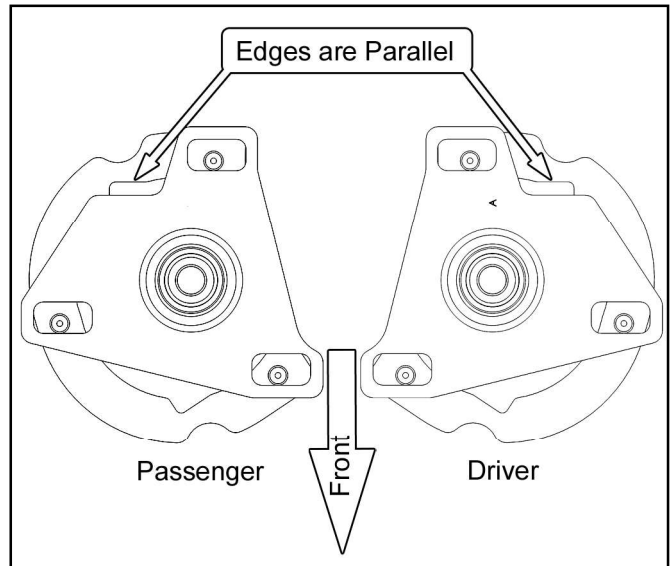

Installation

2. Support the front of the car safely on jack stands.

WARNING: The vehicle should only be lifted and supported by the rocker panel pinch welds. Using the k-member or IRS as a jacking point may cause damage.

3. Remove the front wheels using a 21mm socket.

- Starting on the passenger side, disconnect any clips attached to the strut housing that hold the wheel speed sensor wire, brake pad sensor wire, and electronic strut control wire, if present.

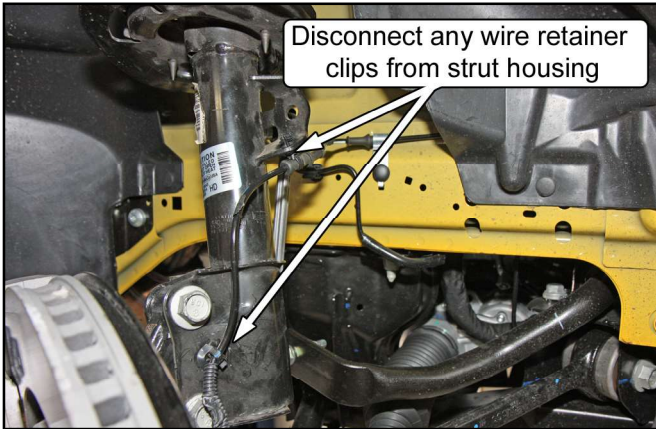

- Disconnect the front stabilizer bar link from the strut housing. Use a 17mm wrench on the flats of the stud to stop it from rotating and an 18mm socket to remove the nut.



- Remove the two bolts holding the caliper to the spindle using a 15mm socket, and remove the caliper from the spindle.

NOTE: Secure the caliper to the lower leg of the k-member. Do NOT allow the caliper to hang by the brake hose as it may damage the hose.

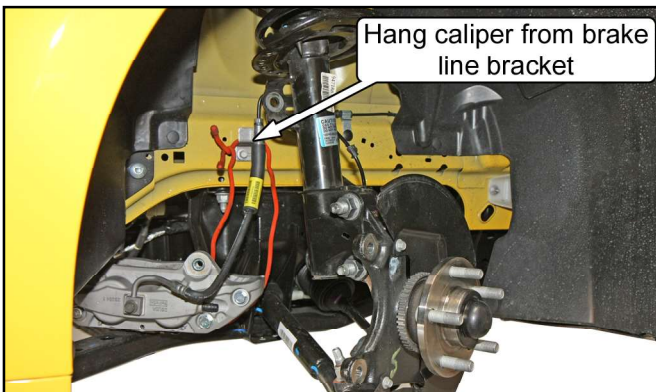

- Remove the brake rotor from the hub.
- Remove, the strut-to-spindle mounting nuts using a 24mm socket.
- Using a hammer, carefully hit the tip of the strut-to spindle mounting bolts to drive them out. They are splined and will require some effort to remove.
- Temporarily install a screw driver thru one of the strut-to-spindle mounting holes to prevent the strut from falling off the spindle in the next step.
- Remove the 3 upper strut mount nuts using a 15mm socket.



- Remove the temporarily installed screwdriver and remove the strut assembly from the vehicle.
- Repeat Steps 4 to 12 for the driver side of the vehicle.

Camber Plate Installation

- Starting with the passenger side strut assembly, compress the spring until tension is removed from the upper spring perch.
- Remove the strut shaft nut and remove the upper strut mount from the strut assembly.

NOTE: The stock spring perch/rubber isolator should remain on the spring.

- Take the passenger side MM Caster/Camber Plate Assembly from Step 1 and install it onto the strut shaft/stock upper spring perch.

NOTE: The OEM upper spring perch and rubber isolator is reused.

17. Reinstall the strut shaft nut and torque to 103Nm (76 lb-ft), if using an OEM strut. If using an aftermarket strut, torque to the manufacturer's specifications.

18. Repeat Steps 14 to 17 for the driver side strut assembly.

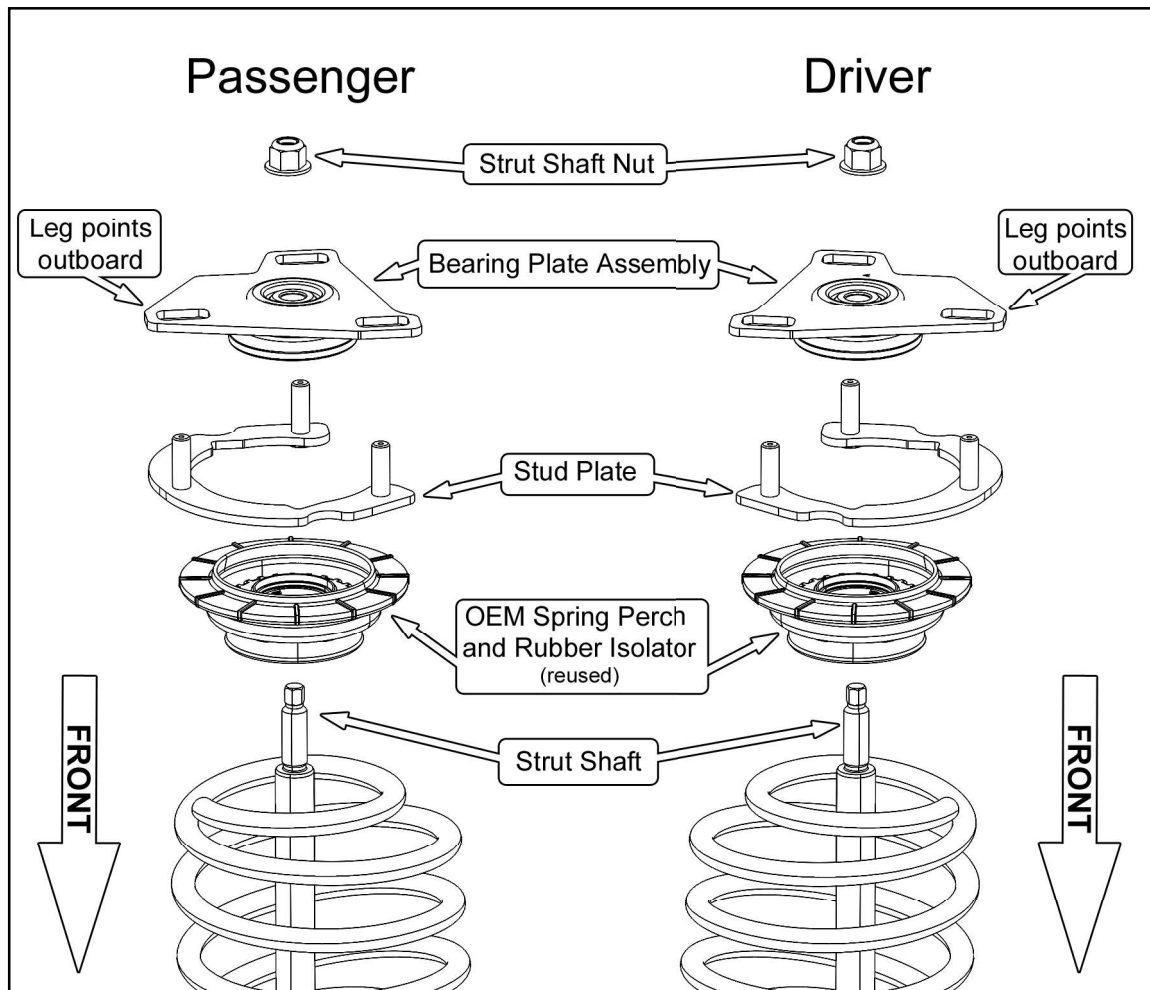

Strut Installation

19. Starting with the passenger side strut assembly, rotate the MM Caster/Camber Plate Assembly so that the legs of the Bearing Plate Assembly (noted in the diagram above) and the ears of the strut housing are pointing the same direction.

20. Lift the passenger side strut assembly into position and insert the Stud Plate mounting studs through the mounting holes in the strut tower.

21. Thread 3 of the supplied 10mm-1.5 flange nuts onto each of the studs protruding up through the strut tower top, but do not tighten.

22. Attach the spindle to the strut ears. Be sure to pass the bolts thru from the front of the spindle.

23. Torque the two strut-to-spindle nuts to 250 Nm (184 lb-ft).

24. Reattach the front stabilizer bar link to the strut housing and torque the mounting nut to 115 Nm (85 lb-ft). Use a 17mm wrench to stop the stud from rotating.

25. Reinstall the front brake rotor.
26. Reinstall the front caliper and torque the 2 mounting bolts to 115 Nm (85 lb-ft).
27. Reattach any of the electrical wires disconnected from the strut in Step 4.
28. Remove the rearward and outboard flange nuts installed onto the Stud Plate.
29. Locate the passenger side Support Bracket and install it onto the two Stud Plate mounting studs.
30. Install one of the provided 3/8 G8 washers onto each stud passing through the Support Bracket.
31. Reinstall the two flange nuts onto each stud passing through the Support Bracket.
32. Install 1 of the provided 3/8 G8 washers under the forward flange nut.
33. Slowly and evenly tighten the flange nuts, making sure all the studs pull up evenly through the strut top. Also, simultaneously push the strut shaft rearwards in the strut tower opening for the initial caster setting, and center the strut shaft side-to-side for the initial camber setting.
34. Torque the M10-1.5 flange nuts to 63 Nm (46 lb-ft).
35. Repeat Steps 19 to 34 for the driver side of the vehicle.
36. Reinstall the wheels and safely lower the vehicle to the ground. Torque the OEM lug nuts to 200 Nm (148 lb-ft).

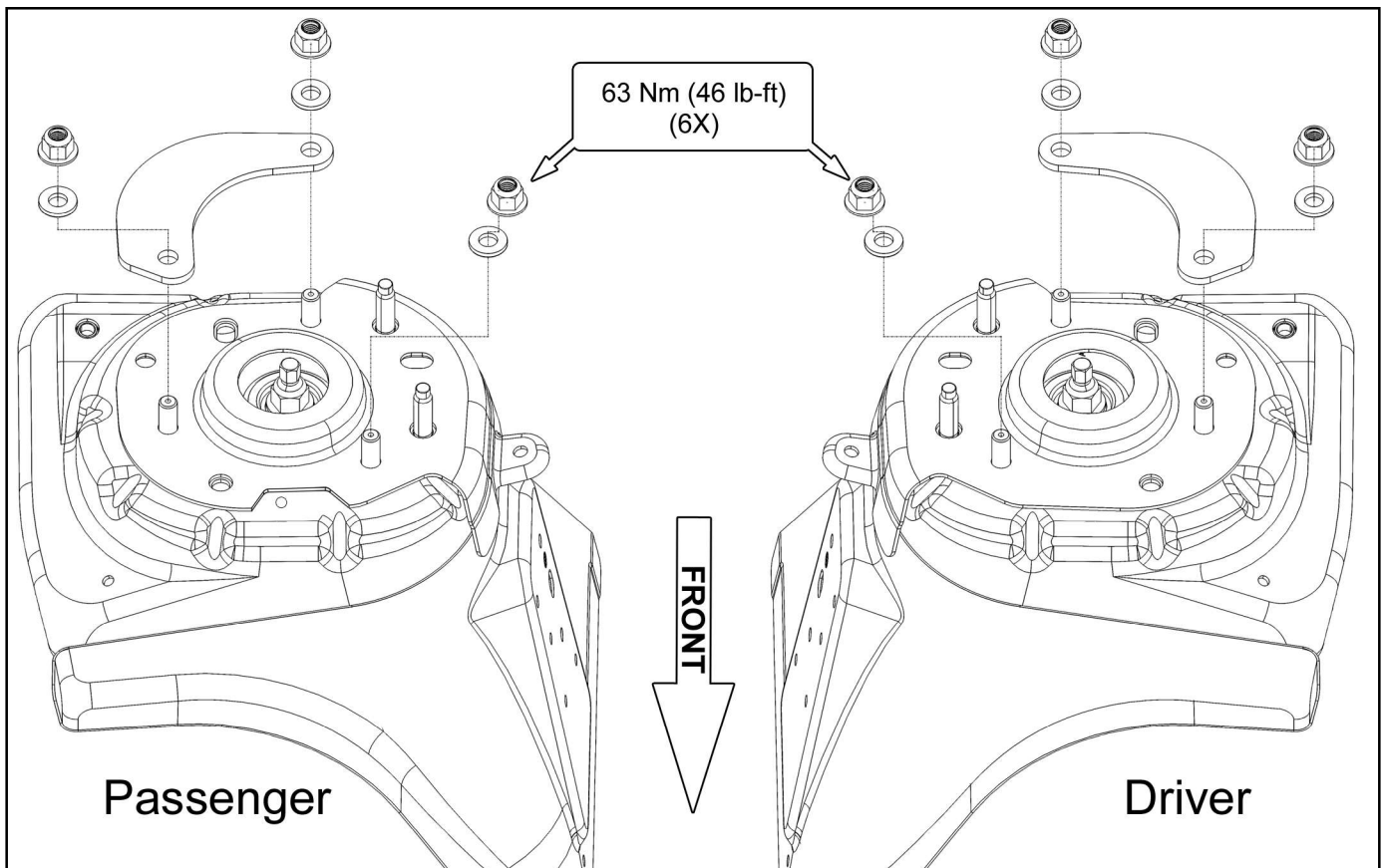

Important Notes for Alignment

- The Caster/Camber Plate will NOT move for adjustment if the front suspension is loaded. The front end MUST be raised.

Alignment Recommendations

Caster

It is typical for alignment shops to set the passenger side caster to a slightly greater amount than the driver side setting. For street-driven cars, a difference of $1/4^\circ$ to $1/2^\circ$ will help counter the effect of road crown, and prevent the car from pulling towards the right on most roads.

Camber

- Street-driven cars: 1° negative, $\pm 1/4^\circ$. Keep a close watch on tire wear patterns, and adjust camber to reduce poor wear, if necessary.

Toe setting

- Street-driven cars should be set at toe-in for straight-line stability. They can be set to the factory specification of 0.2° toe-in.

Remember that any time any change is made to the camber setting, the toe setting will be affected, and must be readjusted. It is a good idea to always keep a record of the alignment settings. Inspect the tires frequently for uneven tread wear patterns. If uneven tire wear becomes evident, have the alignment adjusted. With a record of the previous alignment it will be easier to diagnose the problem and make alignment adjustments to improve tire wear.

Warranty

Maximum Motorsports Caster/Camber Plates part # Mm6CC-10 have a limited lifetime warranty. This warranty applies to the original retail purchaser of genuine MM Caster/Camber Plates. Please check the website for detailed information.

